

Oberflächensensorik mit hoher räumlicher Auflösung Mittels Whispering Gallery Modes

Netzwerktreffen Tribologie, Bad Sachsa

11.03.2022

L. Dähne, M. Olszyna, G. Dähne,
M. Himmelhaus,
C. Guernth-Marschner, M. Kirschbaum,

Surflay Nanotec GmbH
NanoBioAnalytics
Fraunhofer Institute for Cell
therapy and immunology (ICI)



The Companies

Surflay (Surface Layers) founded 2008 in Berlin

- Privately owned Research company, no investors
- 2022: 9 scientists, 1 technician
- Interdisciplinary team: Polymer-, Synthetic-, and Physical Chemists, Pharmacist, Biotechnologists, Engineer
- Surface (bio-) functionalization by Layer-by-Layer LbL-technology
- Monodisperse Nano- and microparticles; Microsensors for pH, T, O₂
- Microsensors for solvent traces in water
- Fluorescence labeled polymers and biomolecules

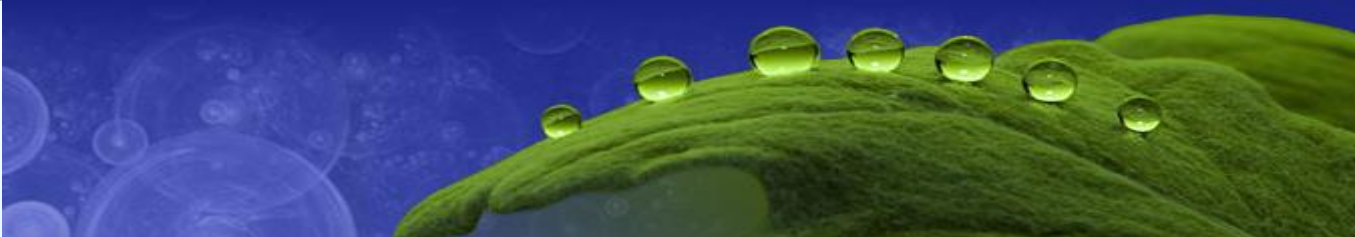

Controlled complex formation: Layer by Layer (LbL-technology)



Charged Substrate (planar, colloidal, porous, surface structured)

+



Polycation in excess, aqueous solution 1g/l,
Control of pH, ion strength



Self-limited adsorption, charge reversal
(ζ -potential + 60 mV), removal excess polyelectrolyte

+



Polyanion in excess



Thickness per double layer
3 nm for PAH/PSS

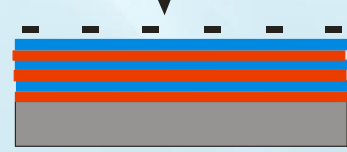

Layer by Layer (LbL)
coated substrate

Outermost layer highly charged and hydrated

G. Decher 1991, reviewed in
Science 277 (1997) 1232

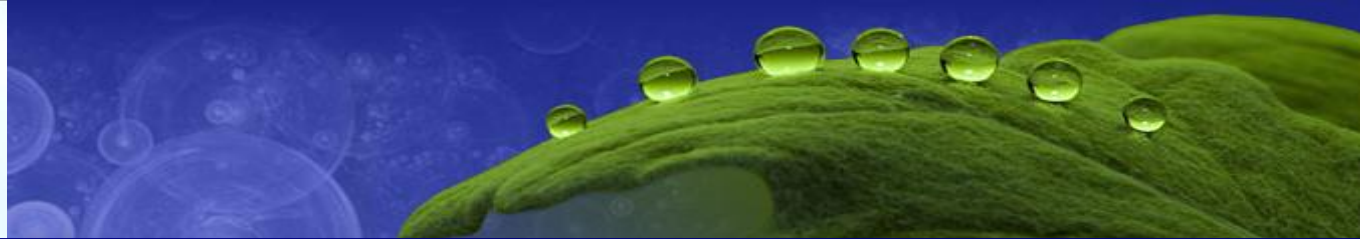

Layer-by-layer coating of the HyperCL



- A labelled coating polymer was applied
 - Uniformly distributed 12 nm layer
 - The polymer penetrates slightly the CL
 - charged drugs for embedding

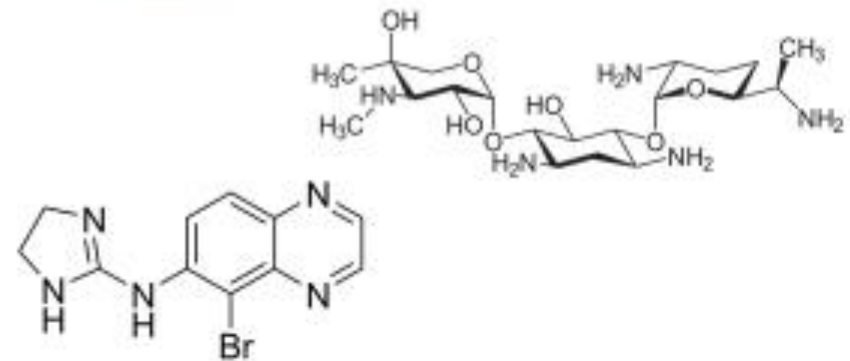
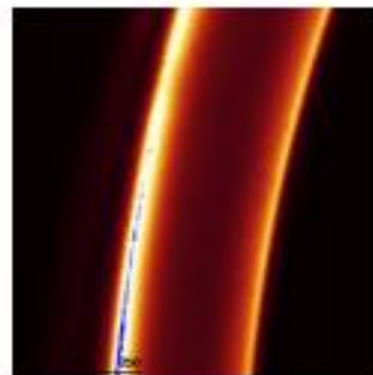
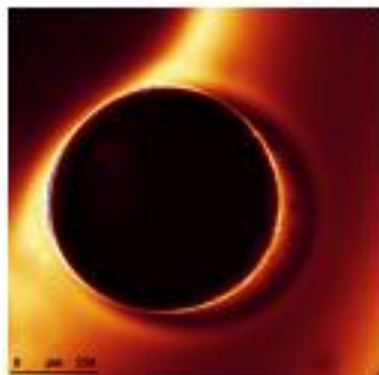
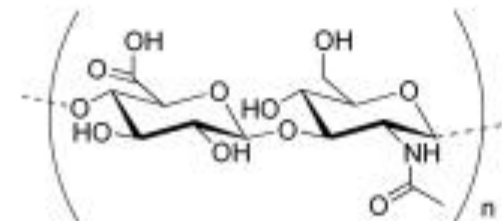

Selected LbL Applications: Hair coloration (P&G)



- Covalent linkage of different dyes with polycations
- 4 layers on hairs (two polycations) after washing

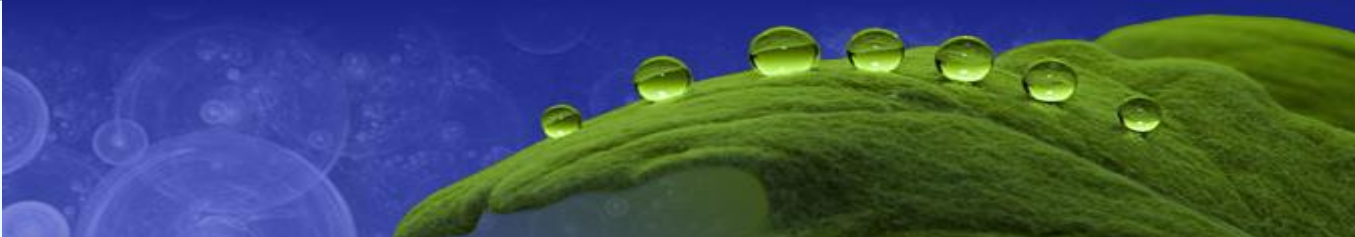



Selected LbL Applications: Friction (Optimol)

Exemplarische Ergebnisdarstellung



„Surflay-lila“, trocken (links) vs. „Surflay-gelb“, trocken (rechts):

lila Scheibe	gelbe Scheibe
(PAH/PSS) ₄ /(PAH/ND) ₄ / (PAH/PSS) ₂	(PAH ₄₀ / PSS70) ₈
	

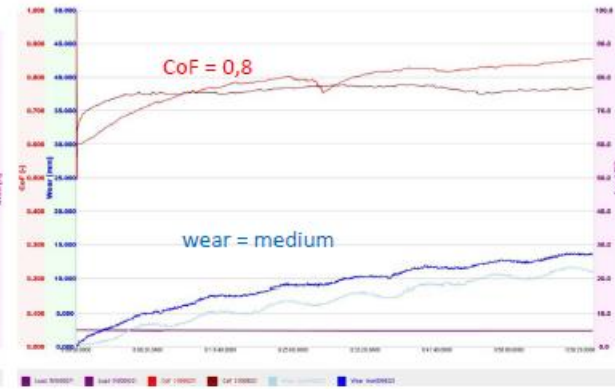

- vergleichbares Reibniveau im Trockenem (rote Kurven) zw. „lila und gelb“
- bei ähnlichen Reibungsverhalten deutliche Verschleißunterschiede (blaue Kurven)

- different layer combinations:
- due to high osmotic pressure less friction in water

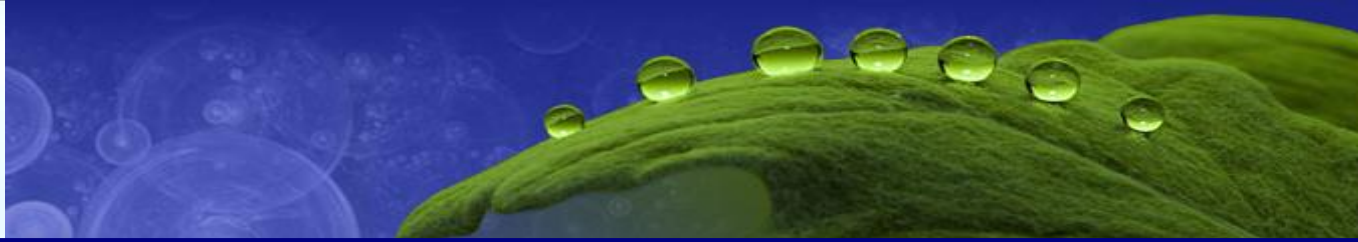

Particle preparation (Polystyren, PMMA, MF)

REM

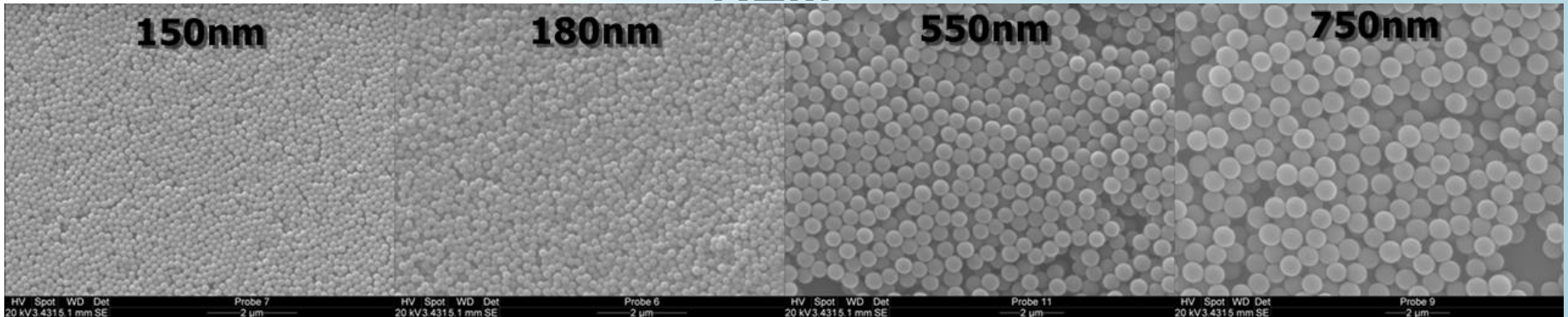

CLSM

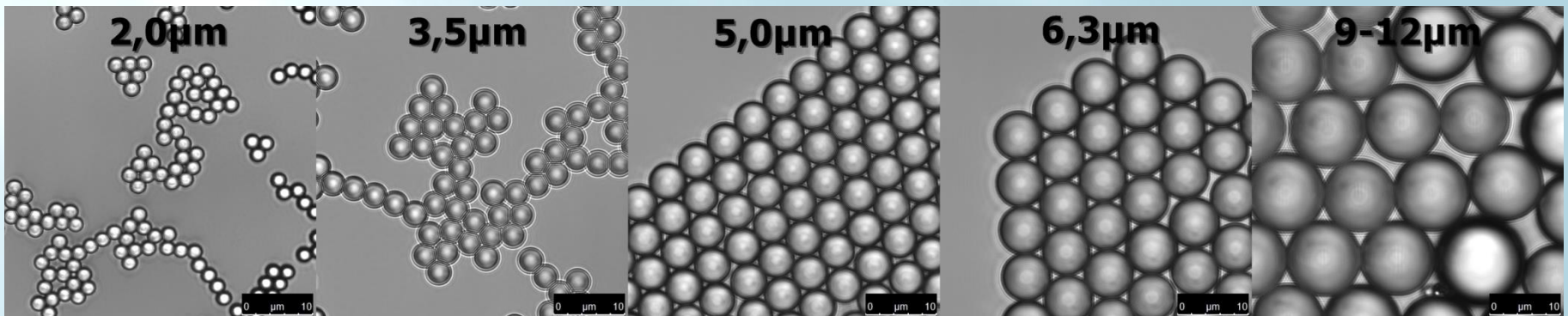

→ PS-Partikelgrößen (monodispers) : 100nm – 100 µm

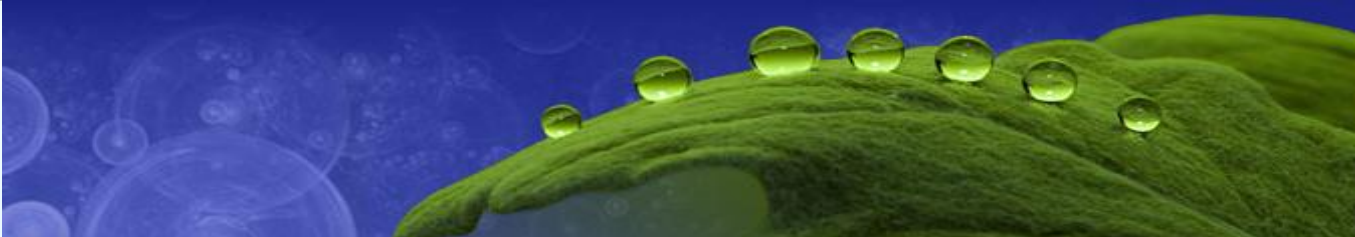

LbL-immobilized pH and oxygen sensors (Glas of Prof. Enke, Leipzig)

→ increasing pH value

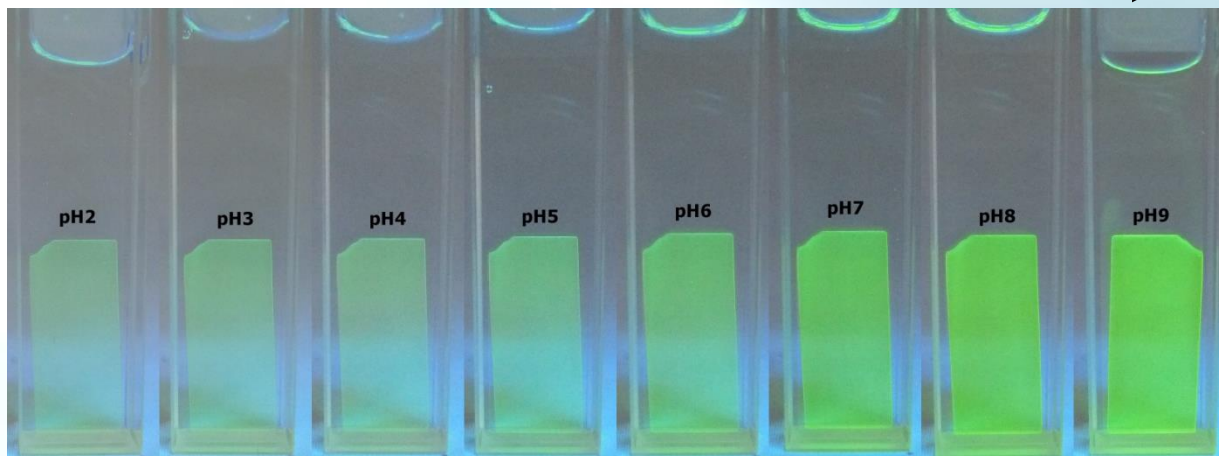

Fluorescence of porous Glas-Slights (20x8x0.5 mm³ coated with PEI-HPTS/PSS from pH2 til pH9

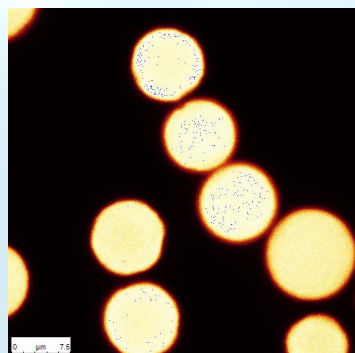

PEI-HPTS
coated porous
SiO₂-Particles
10 µm

Fluorescence: internal
Reference necessary:
Adding Cy5 dye pH
independent

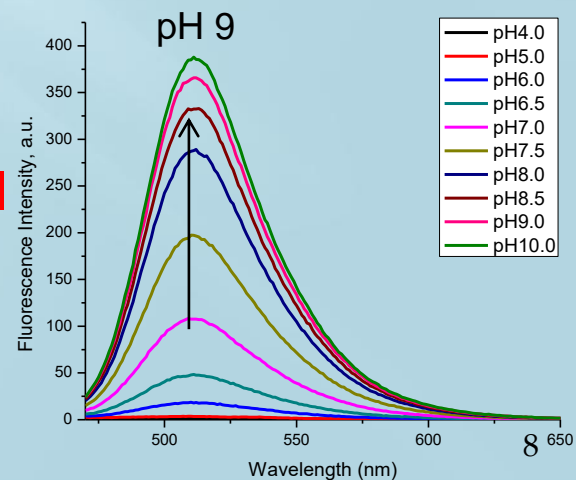
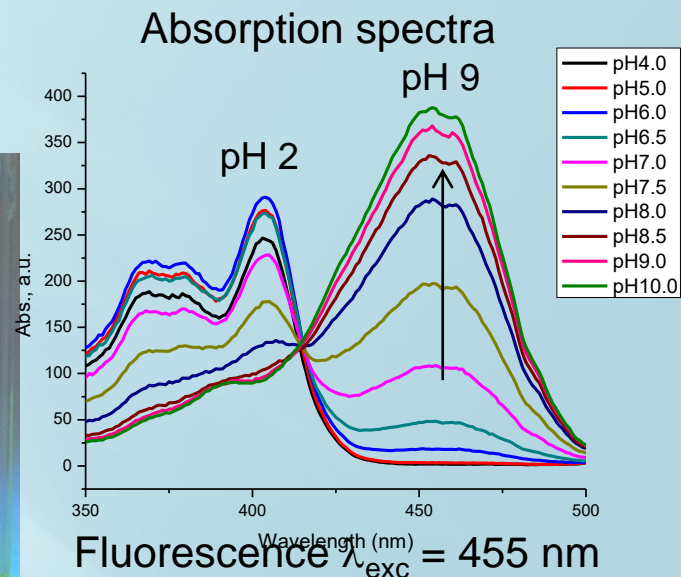

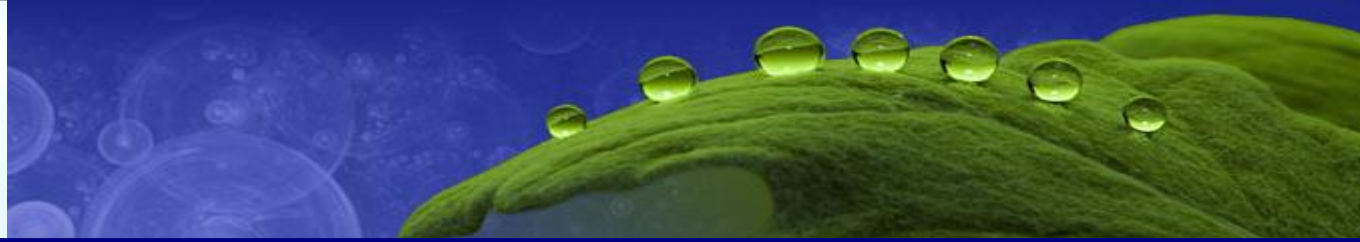

Label free analysis of specific Interactions on surfaces

- **Surface Plasmon Resonance (SPR)**
 - Biacore, Chips 60 - 400 €
- **Quartz Crystal Microbalance**
 - Chipsensor 25-100 €
- **Ellipsometry**
 - large planar surface
- **Reflection Interferometry RIFs**
 - smaller planar tips

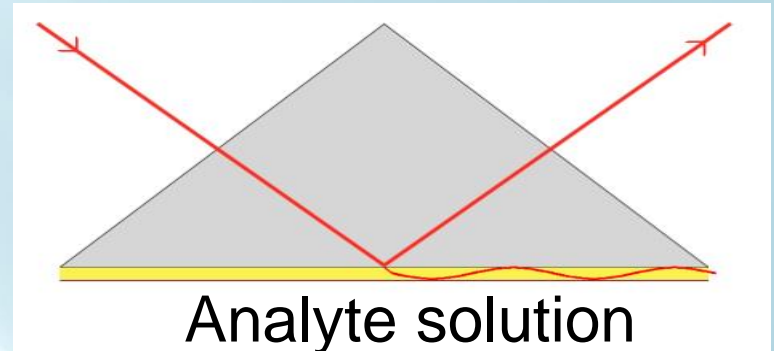

Planar wave on gold coated
Surface area, area 16 mm²

Miniaturization of sensor??

Very old Idea

**Ancient times:
FLAT is good**

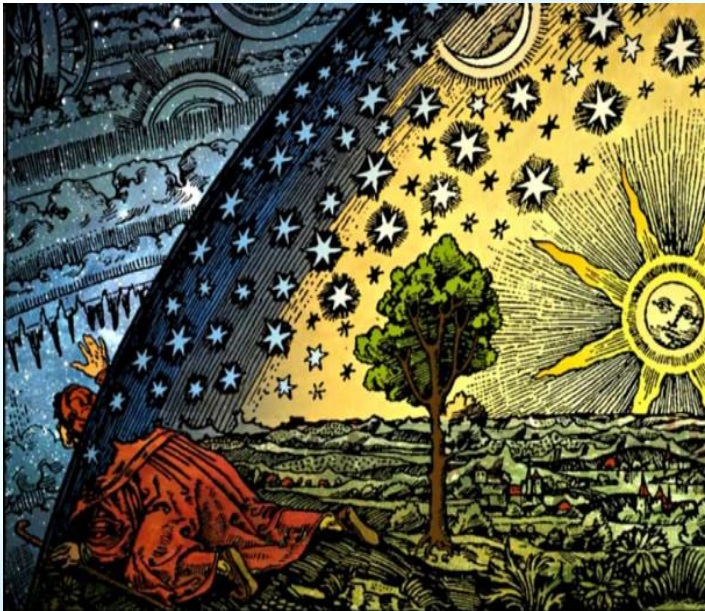

**Kopernikus:
ROUND is better**



- Transformation of planar in circular waves
→ Whispering Gallery Modes WGM

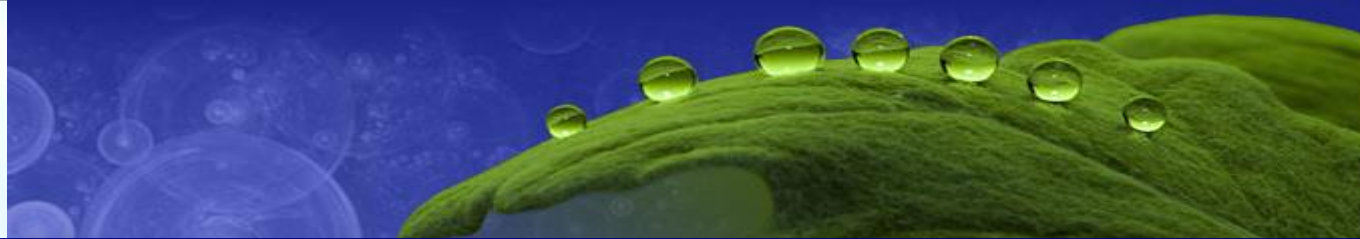

Principle Whispering Gallery Modes (WGM)

Acoustic whispering gallery

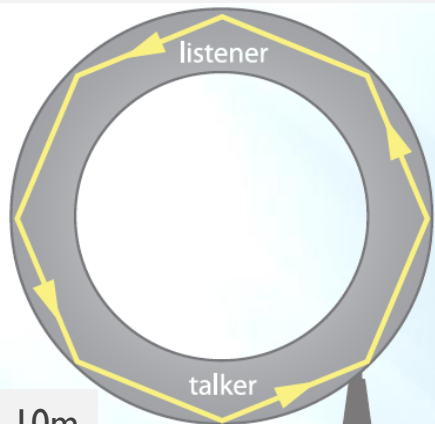

10m

Optical whispering gallery

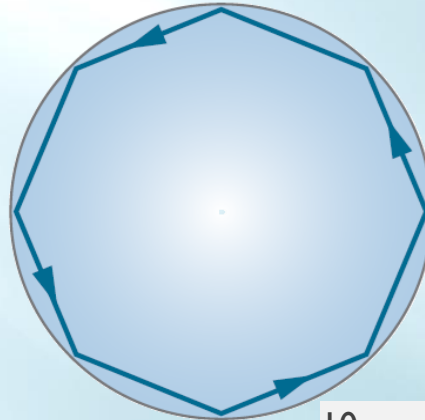

10 μm

total internal reflection
for incident angle $\theta > \theta_c$

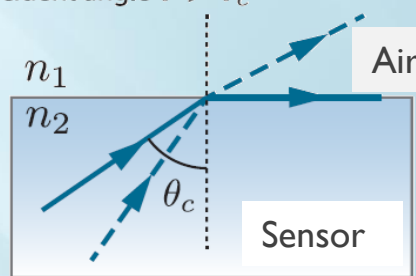

whispering gallery

St. Paul's cathedral

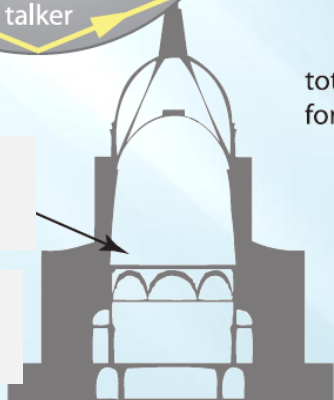

WGM: Reflexion and Interference from waves in circular cavities of high RI

Acoustic waves: Middle age: Secret listening of important talks
Saint Pauls Cathedral London;

Optical waves: smaller circular space
Light wave totally reflected inner surface,
→ only resonant waves circulates

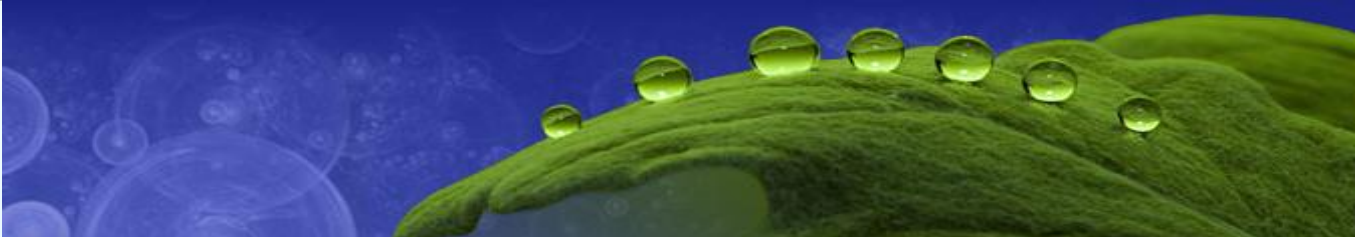

How to immobilize light waves into media of higher refractive index:

a) Tunneling, b) Low Q WGM in fluorescent particles

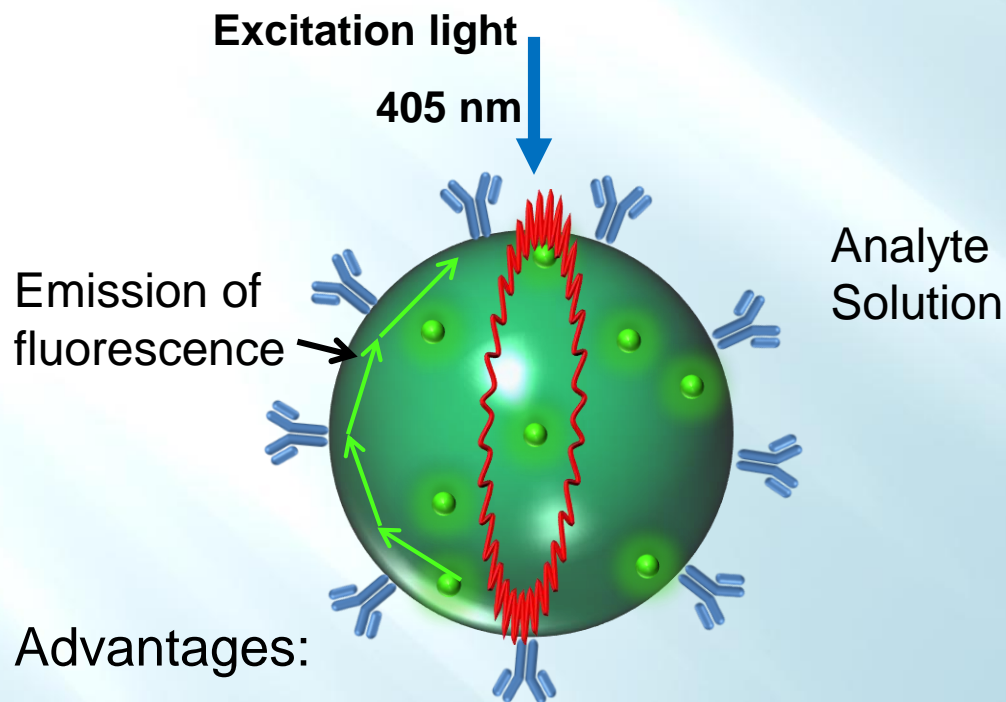

Surface area of 10 μm Particle
0.0006 mm^2 (SPR 16 mm^2)

Advantages:

- Tiny sensors → measurements in small cavities
- No connection to measuring unit necessary → simple use of microfluidic
- Very small amount of analyte molecules needed

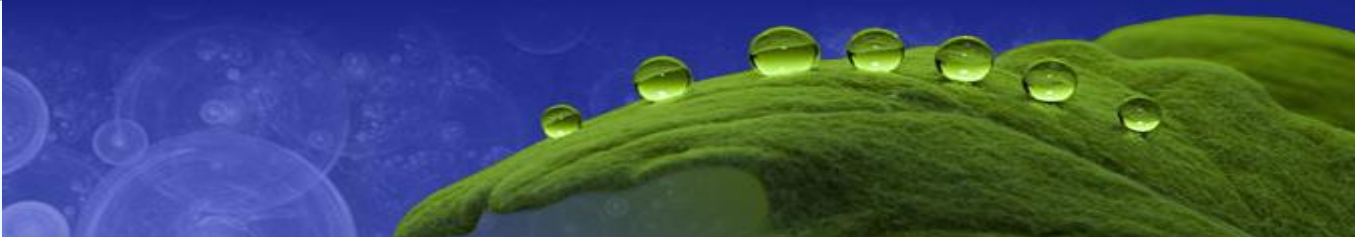

Measured signal

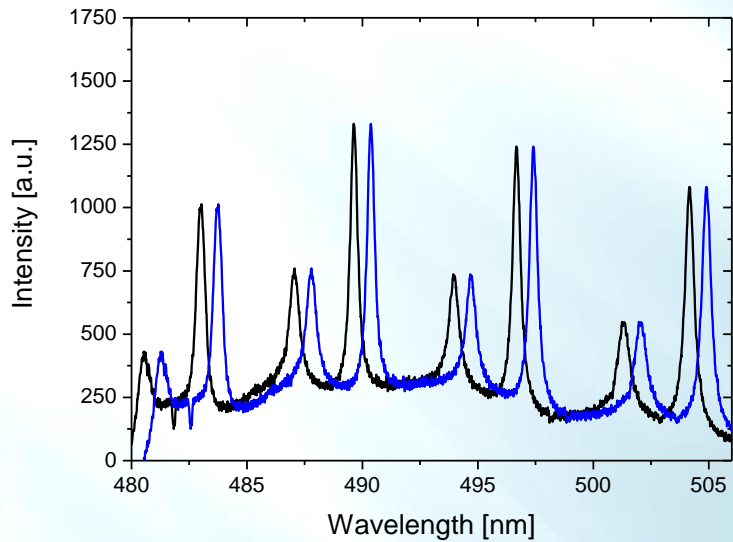

Emission spectrum of 1 particle
Before and after adsorption

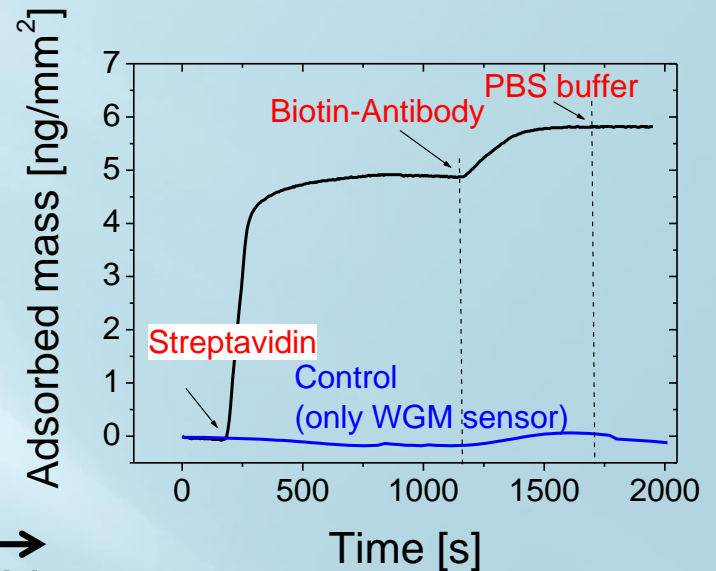
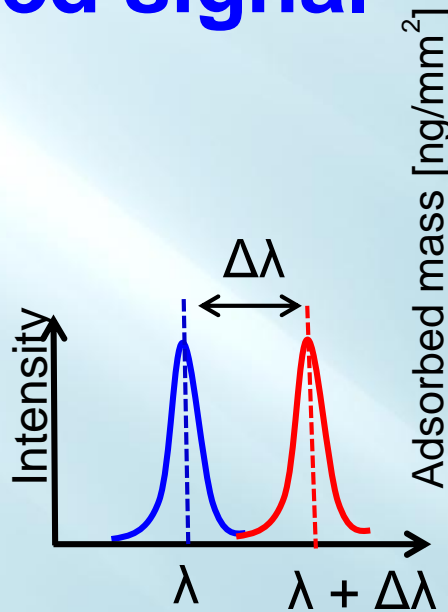

Signal shift transformed
in adsorbed mass
→ Typical adsorption kinetics

- FWHM WGM peaks 150 pm for 10 μm particle
- Shift for monomolecular (antibody) coverage around 400 - 800 pm
- Instrumentation for measuring (WhisperSense) resolution 6-10 pm

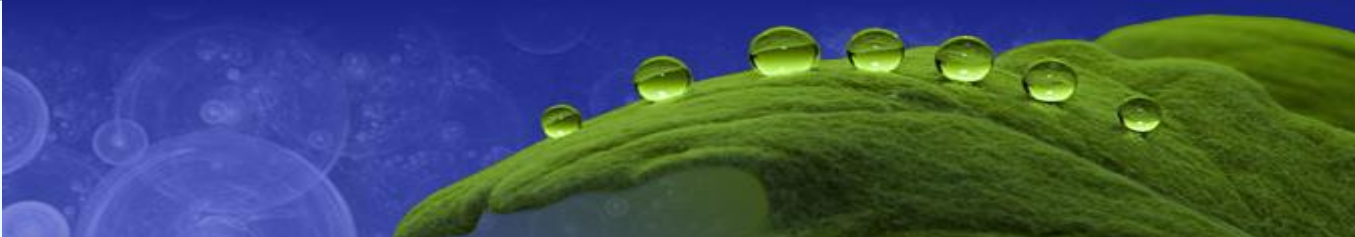

Further Miniaturization??

WGM Spectra of different bead diameter

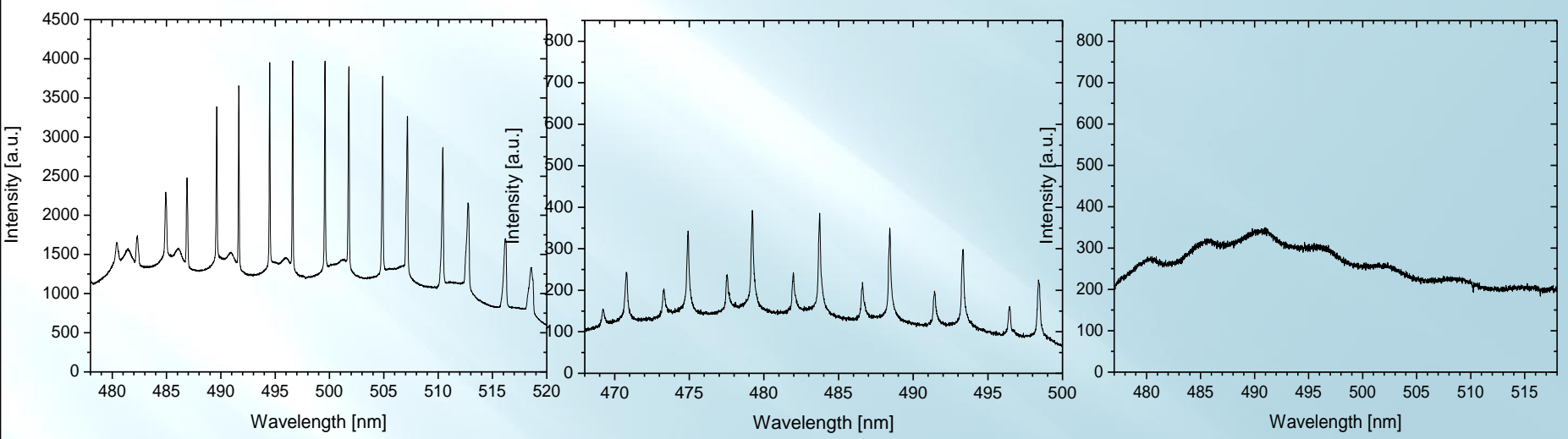

Particle diameter

9.5 μm

7.2 μm

5.8 μm

Decreasing Q-Value \longrightarrow

Circ. 10 000

< 3 000

< 500

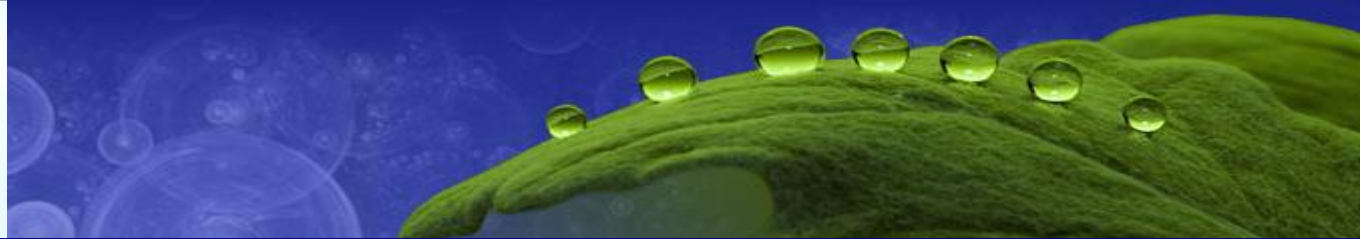

Instrumentation “WhisperSense” (Surflay, NanoBioAnalytics)

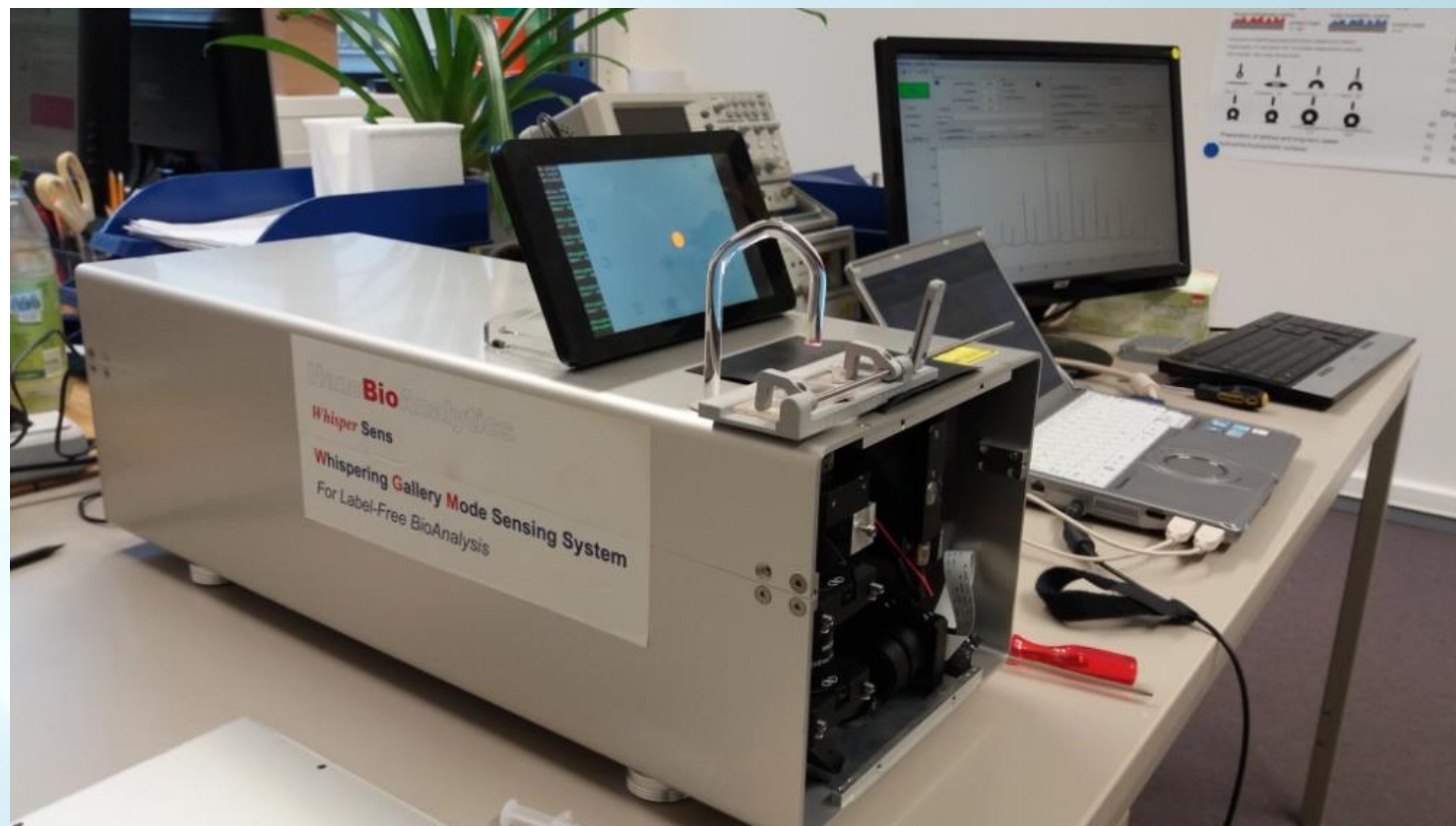

Box (25 cm x 30 cm x 58 cm) integrates excitation laser, spectrometer, camera, computer and automatic xyz stage; Wavelength resolution 6-10 pm



Application Examples:

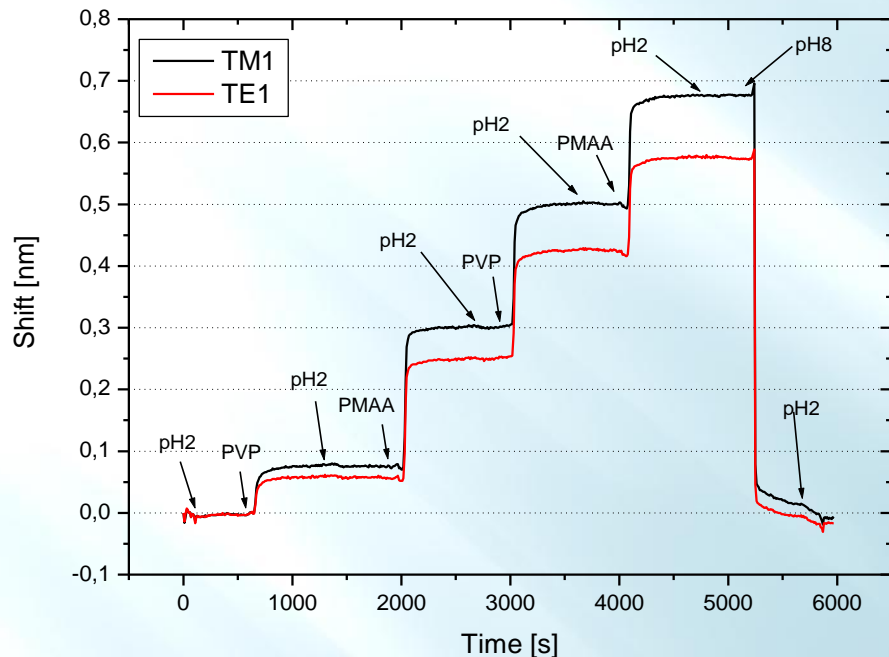

Stepwise Layer-by-Layer Coating of approx. 1 nm thick polymer layers + final complete removal of layers

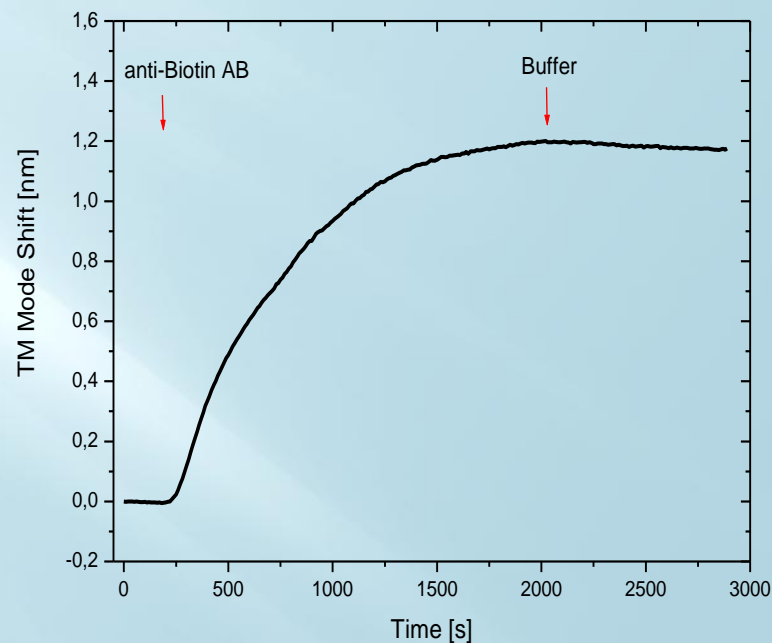

Coupling of antibody anti-Biotin (25 µg/ml) on biotinylated surface

➤ Typical adsorption kinetics as for SPR or QCM

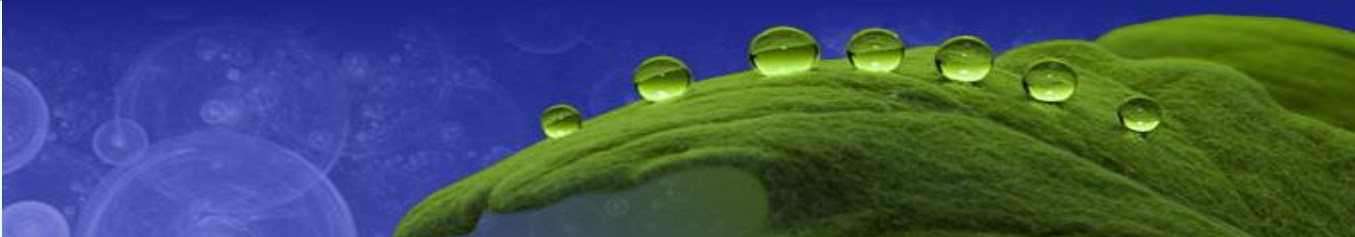

Application: Release of polymers/drugs from surfaces

- Hydrogen bonded
Films: PVP/PMAA pH =2
- pH > 4 deprotonation of
PMAA (pKa) = 6.2
- Decreasing H-Bonds
- Increasing negative
charge → repulsion.

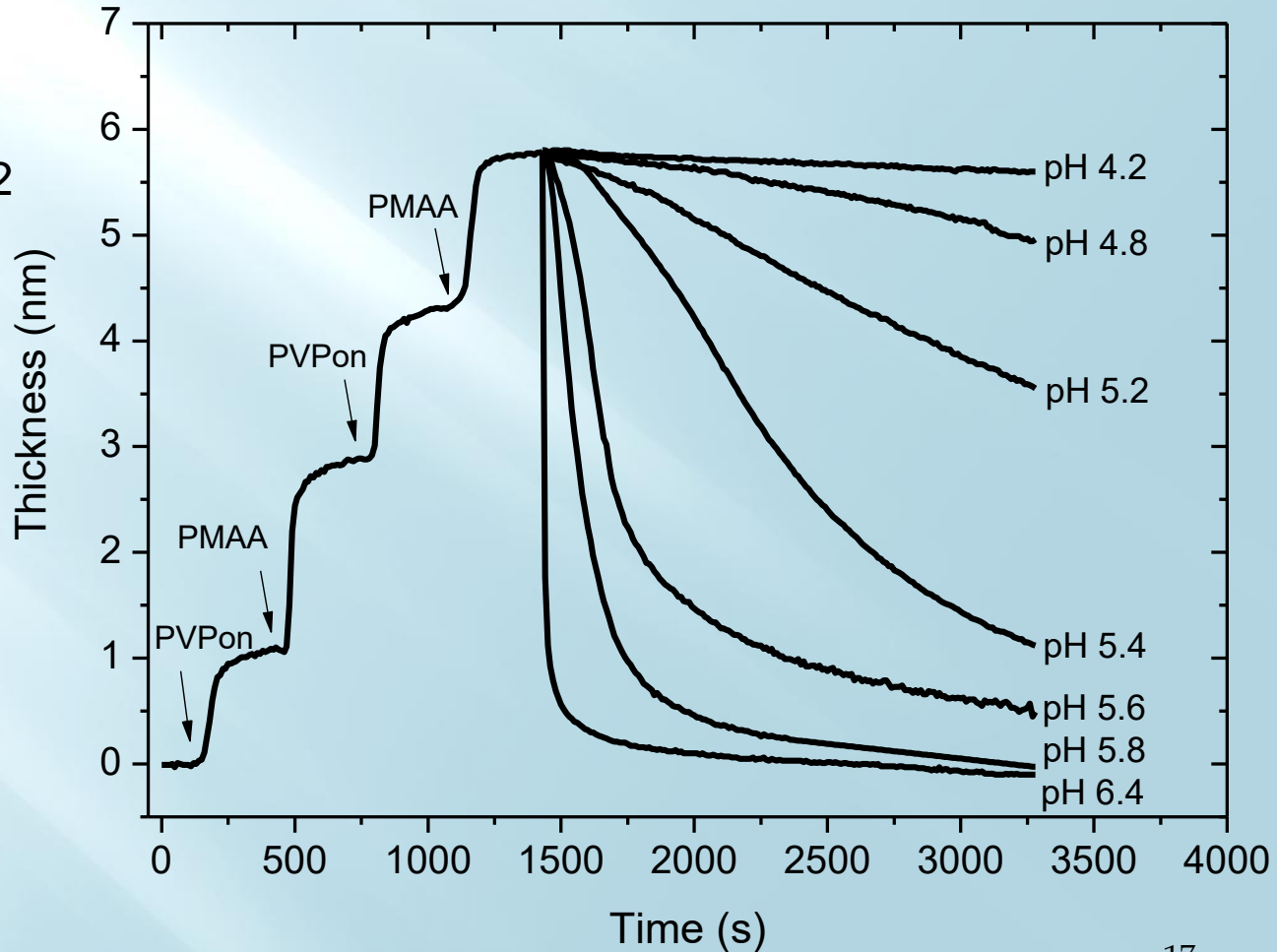

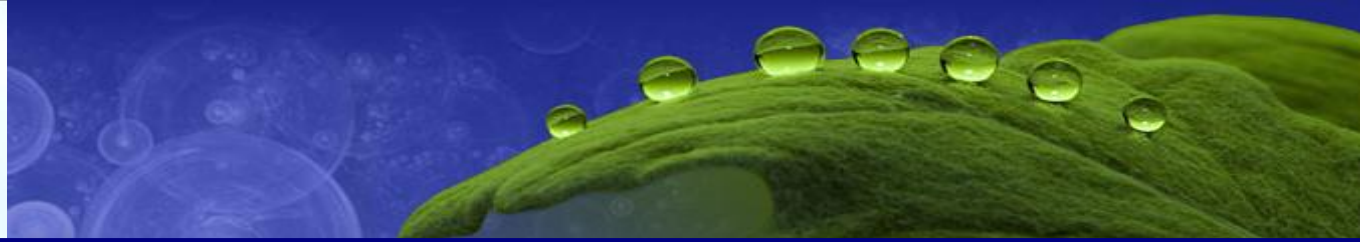

Difficulty: Immobilisation of sensor particles

- Even for apparently monodisperse particles: Each particle has individual WGM pattern
- measurement on **one and same** sensor particle necessary
- Requires immobilisation of 10 μm particles in analyte stream

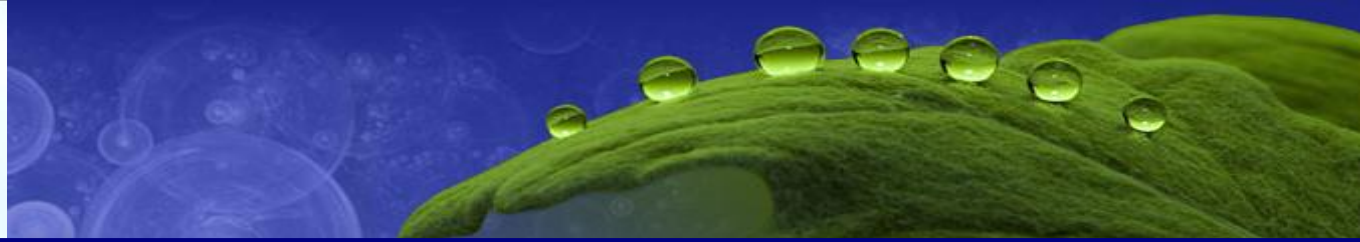

Possible (microfluidic) approaches:

1. Micropipettes
2. Pillar structures
3. Laser tweezer
4. Dielectrophoretic immobilization
5. Well arrays
6. Water droplets in oil phase
7. Between cells in cell culture

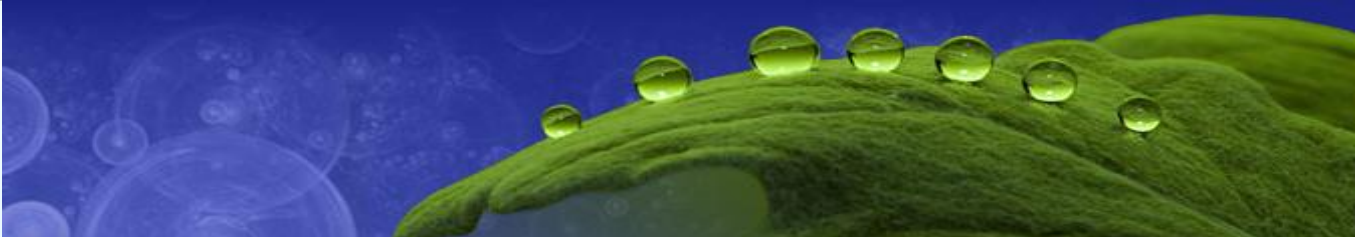

1. Micropipettes

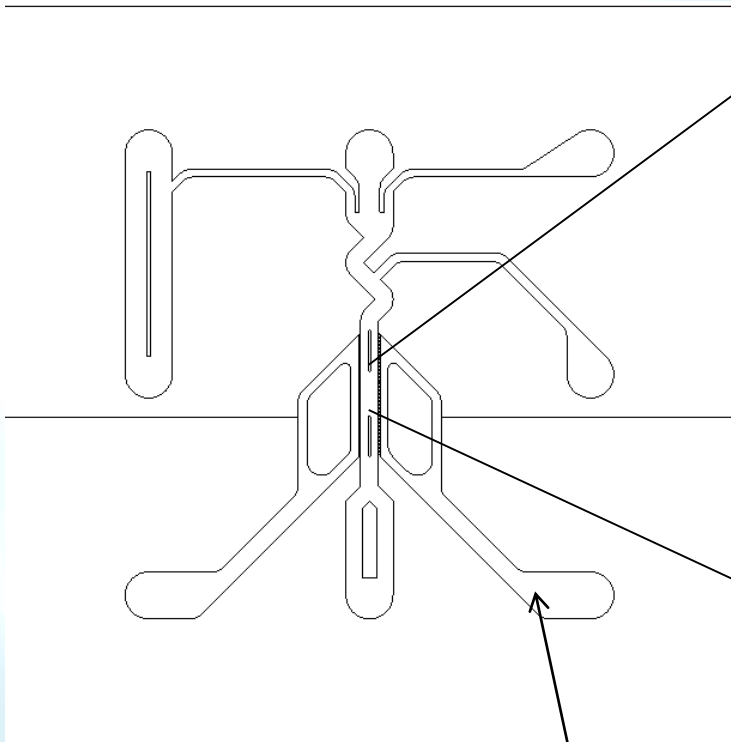

Reduced pressure

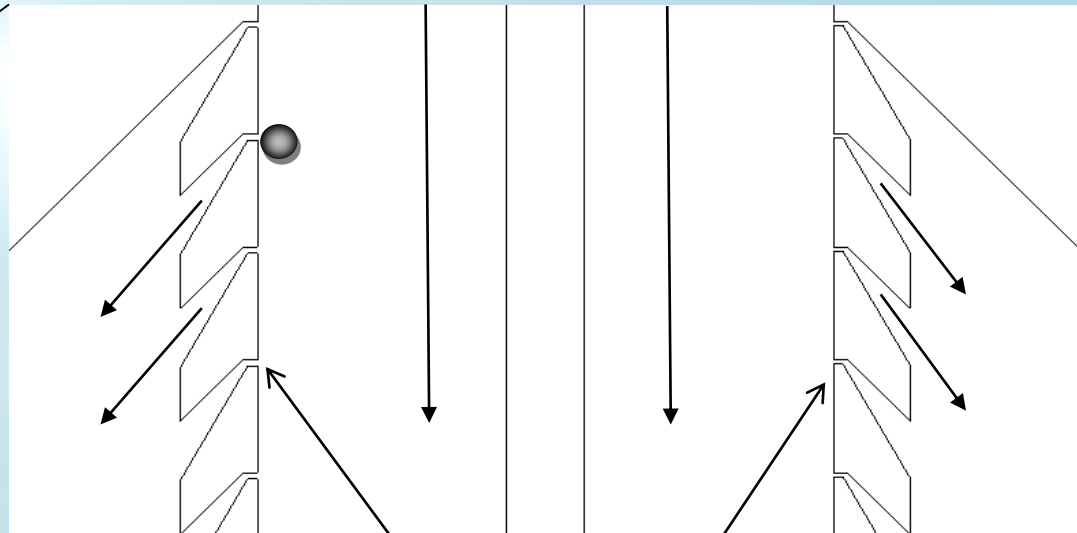

Micropipettes (PDMS)

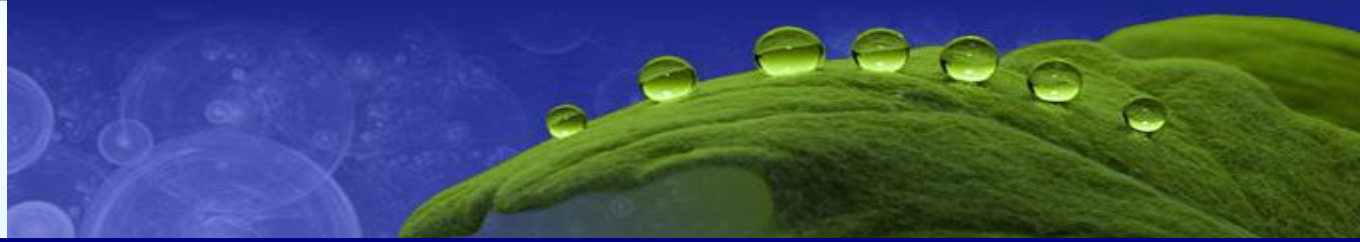

Micropipettes

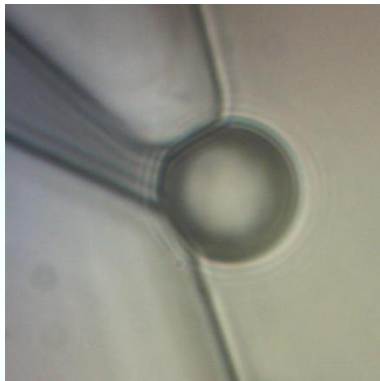

I



II

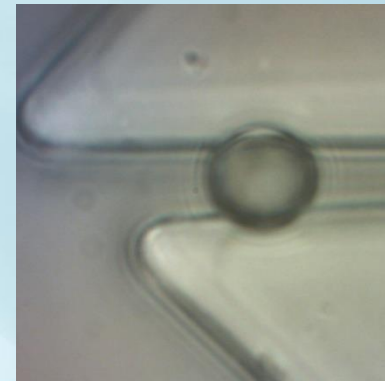

III

PDMS too soft, Contact phase to particle too large

→ Disturbing WGM signal

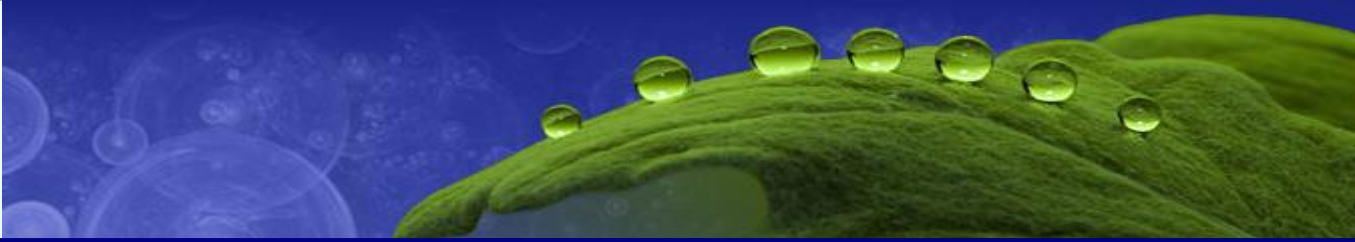

2. Pillar blocking structures

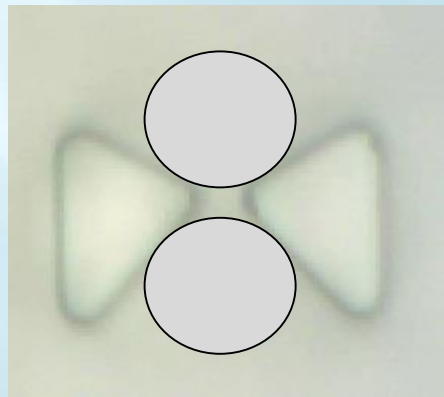
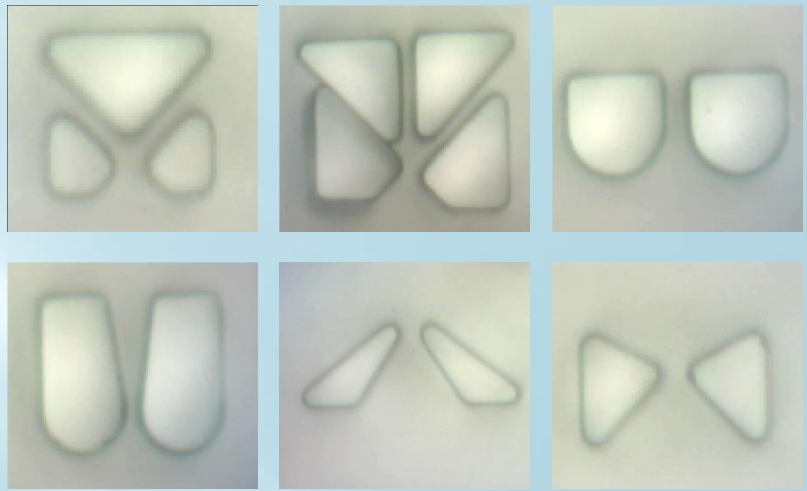
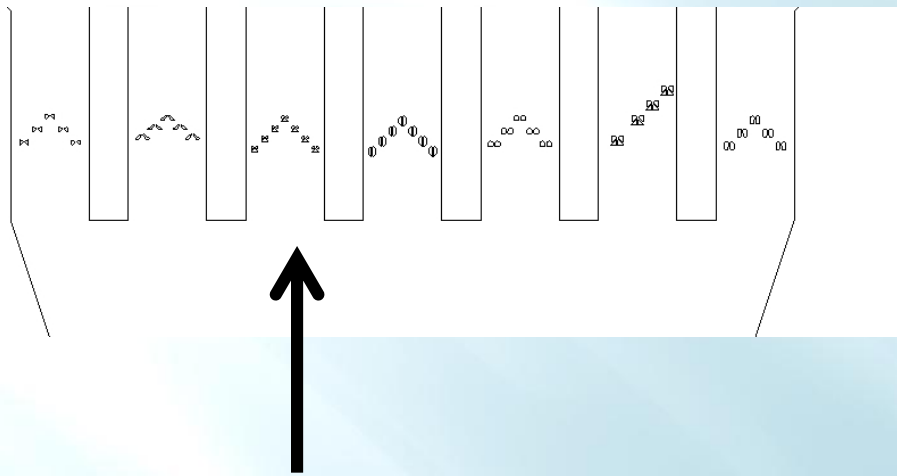

- Pillars of PDMS too weak
- Stream from backside
- Removal of used particles not possible by backflushing

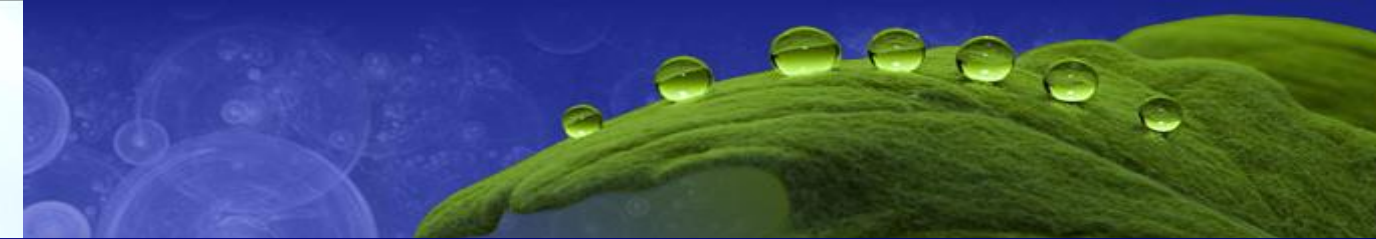

3. Laser Tweezers

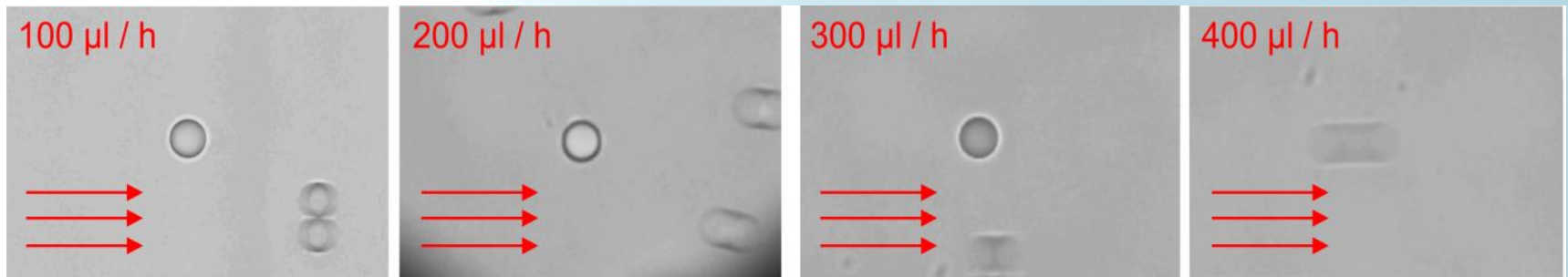

Continuous long term measurement

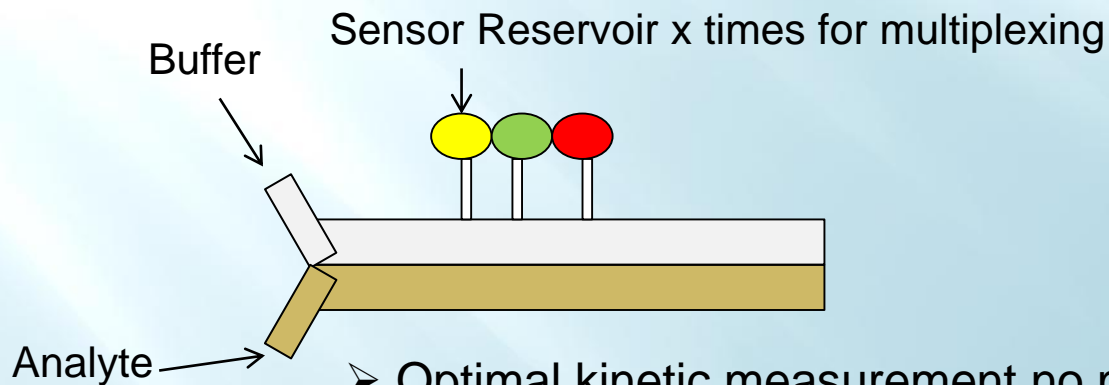

- Optimal kinetic measurement no mixing effects in microfluidic
- WGM Signal not influenced by Laser tweezer
- Promising technology
- Implementation in WGM instrument exceeds our present capacity

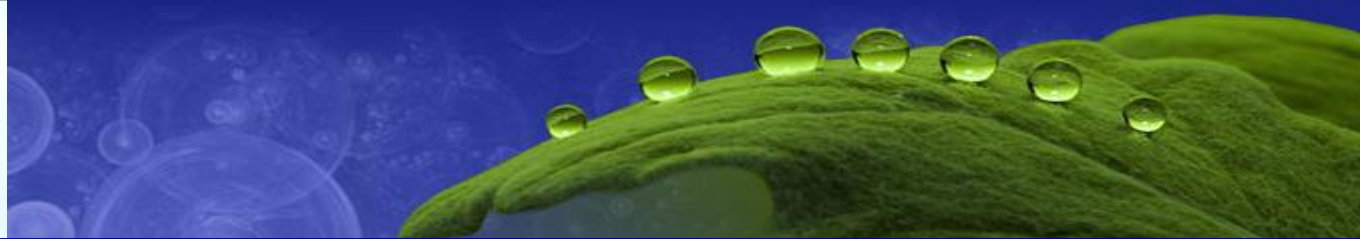

4. Dielectrophoretic immobilisation

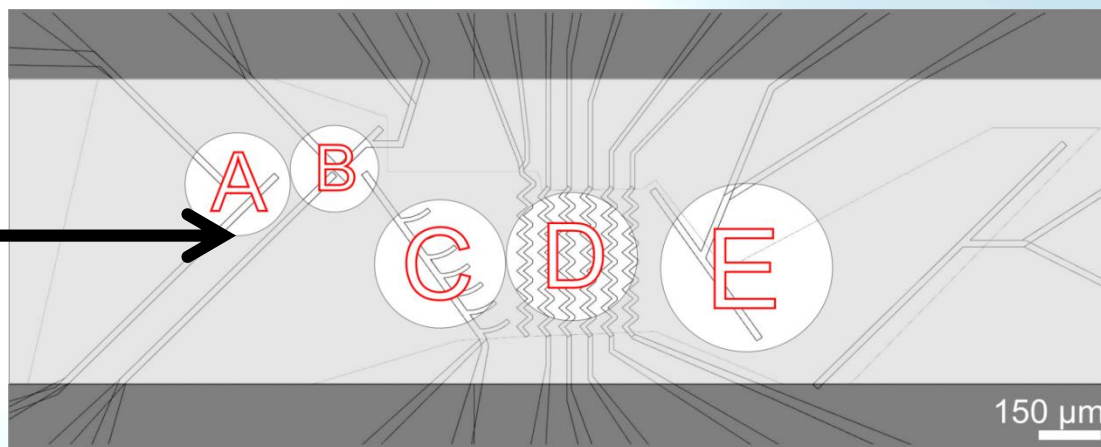

Arrangement of electrodes for particle sorting

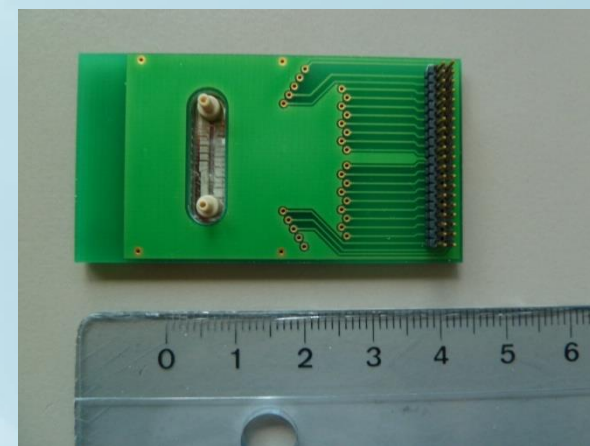

Dielectrophoresis-Chip

- Dielectrophoresis chip for continuous particle handling
- Electrode structures for particle handling
- Separate switch On/Off

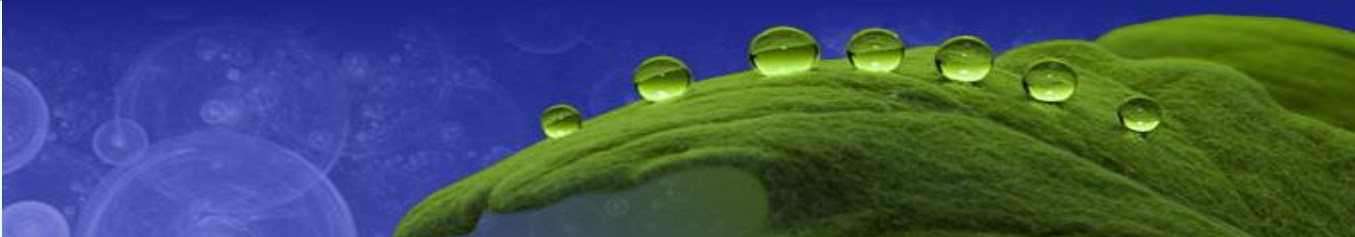

Dielectrophoretic immobilisation

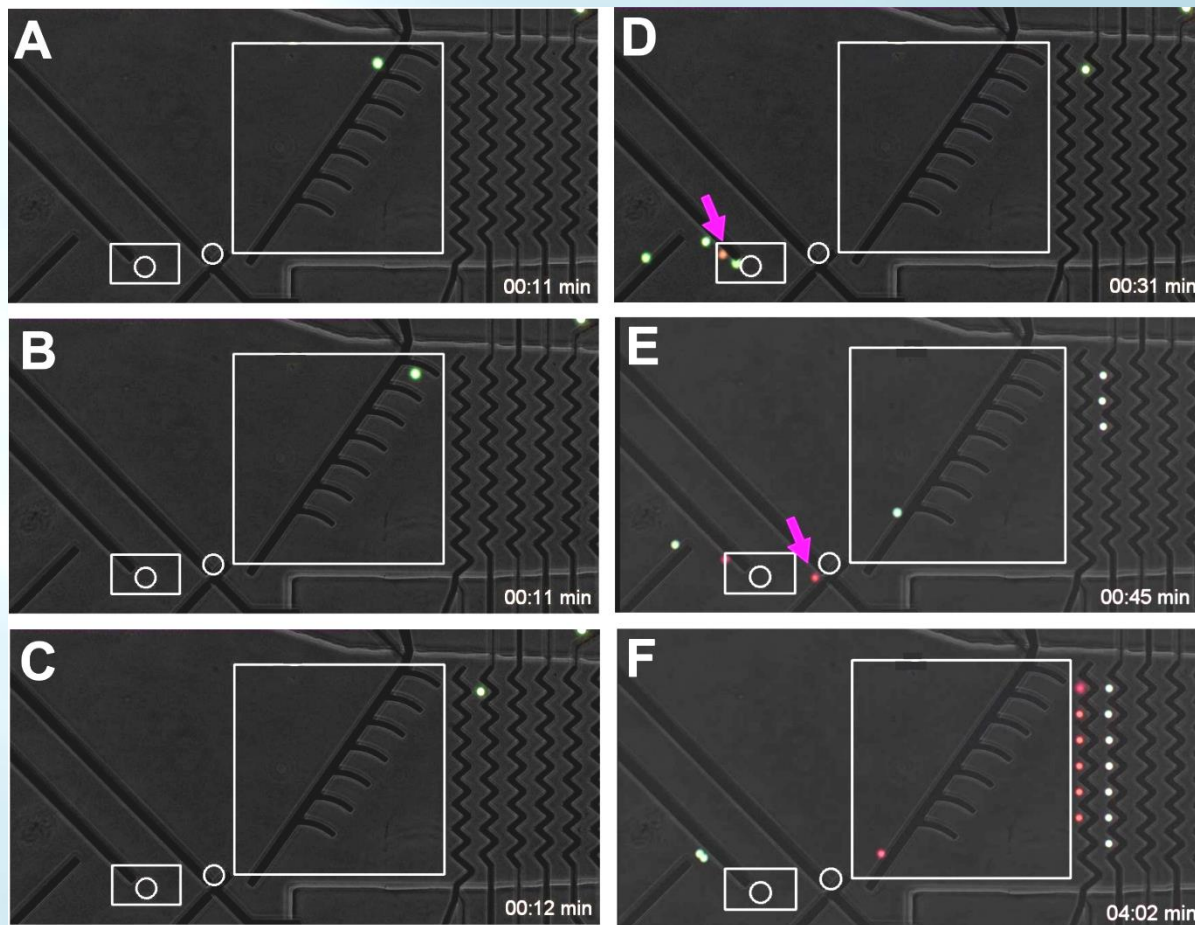

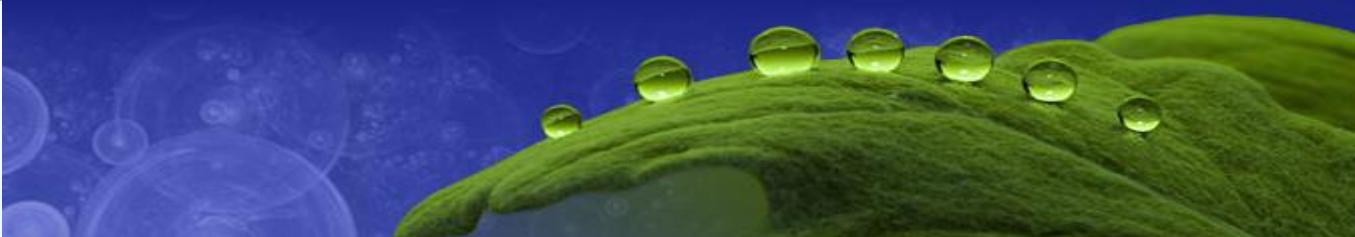

Possible Flux rates

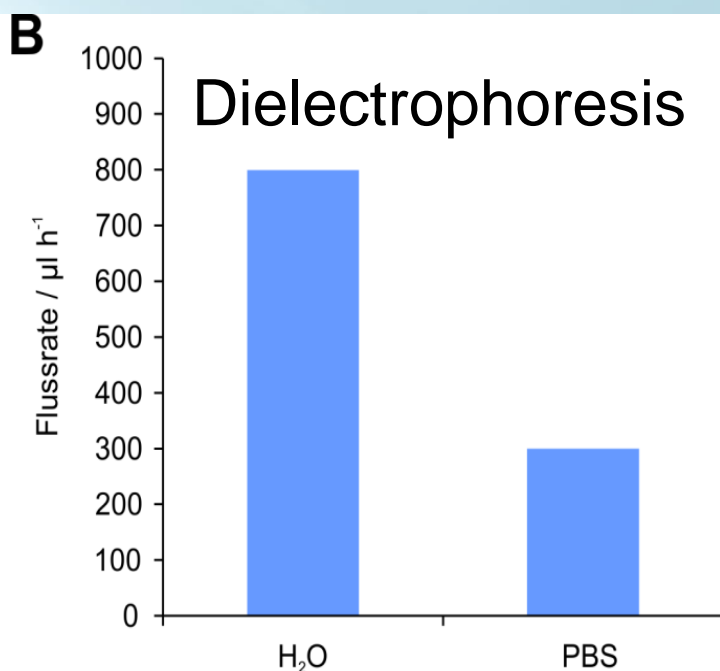
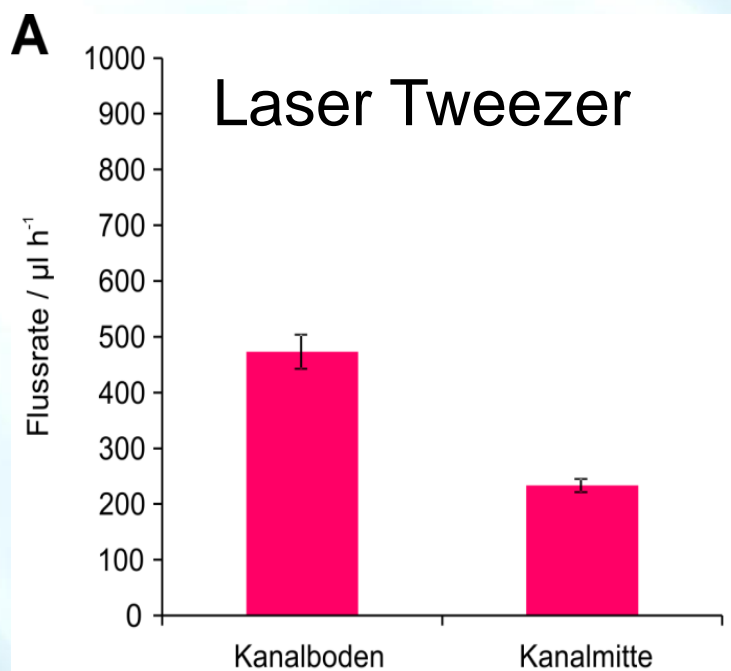

Flux rates limited, approx. 20 times less than Biacore

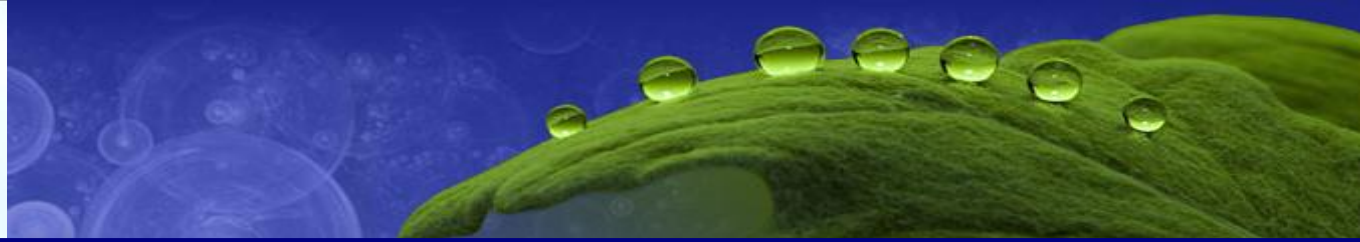

Multiplexing: Immobilisation of particles in microfluidic well arrays

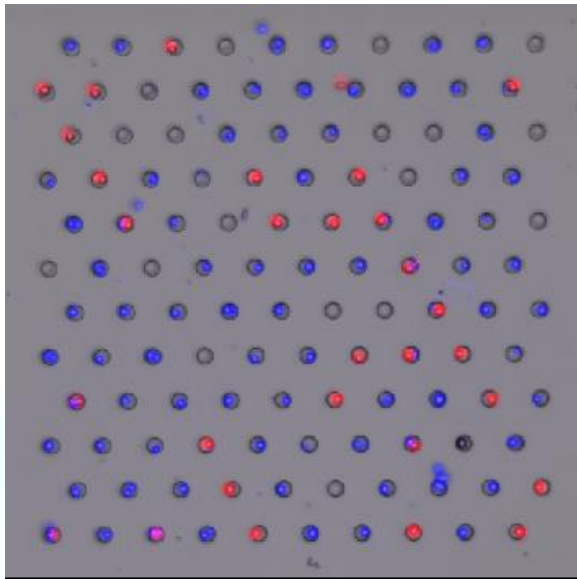

500 μm x 500 μm

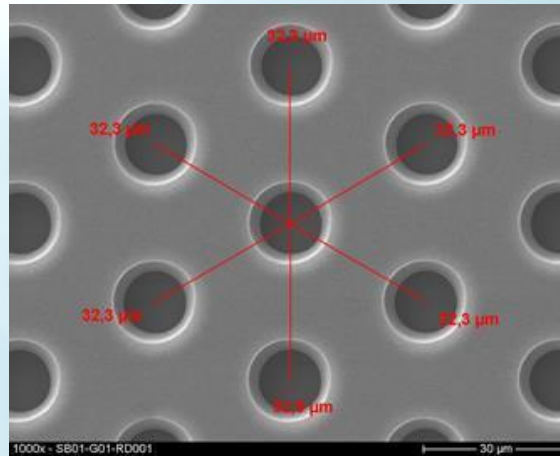

Bottom

Stratec Consumables GmbH

Excellent structures, $d = 12 \mu\text{m}$

1 000 well array

Microscopic image of immobilised Beads in cylindric wells,
Only 1 particle/well possible

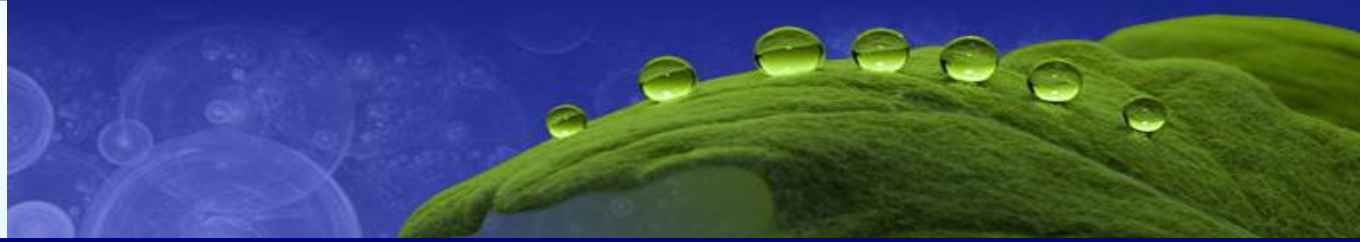

Microfluidic cells

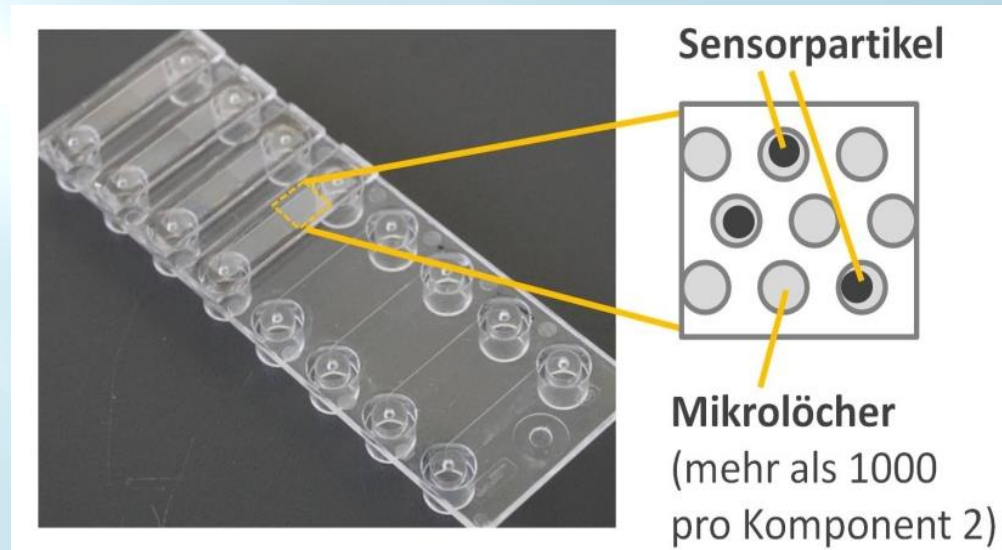
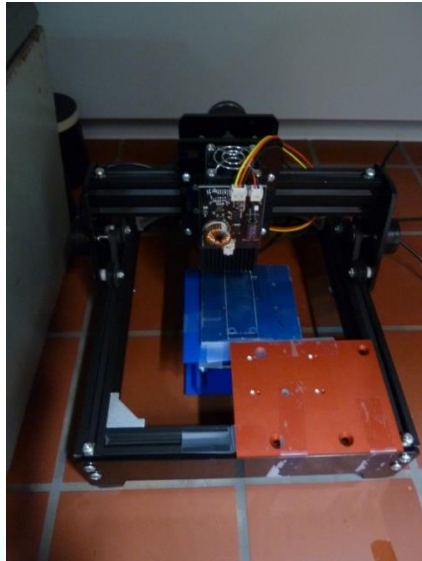

Connection of Stratec Well array with Lids of ChipShop;
Laser welding, 6 channels a 1000 sensors
→ Enables Multiplexing and High statistic safety

- Multiplexing:**
- a) bead position,
 - b) bead size 6-12 μm
 - c) fluorescence encoding

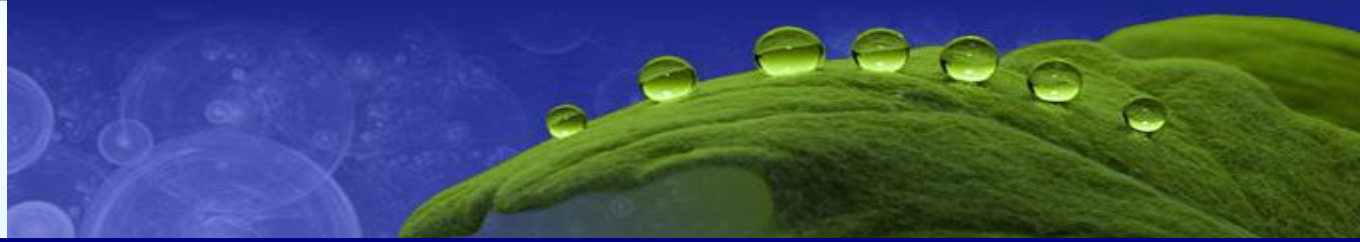

Multiplexing by bead position

Requires different beads in defined positions (of STRATEC arrays)

→ New spotting technology of
SCIENION enables defined
positioning of cells or particles

(Image of spotted WGM particles →

Automatic xy positioning in WGM
find particles within the circles)

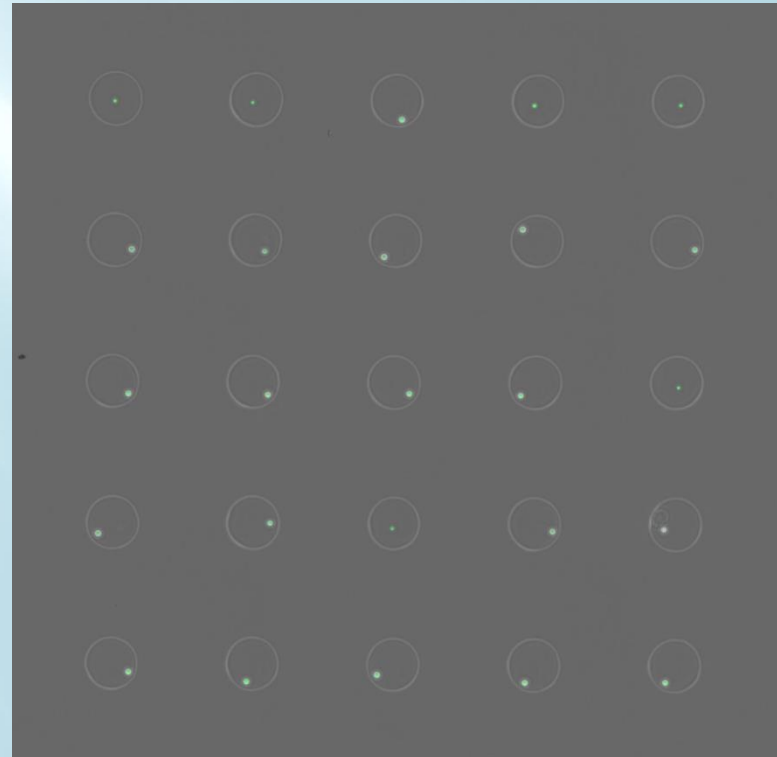

BMBF Project „ImmunoPlex“ with SCIENION and DIARECT

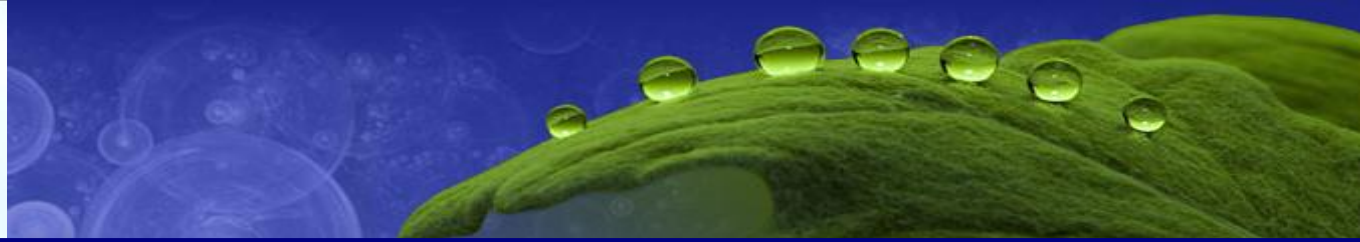

6. WGM beads in droplets

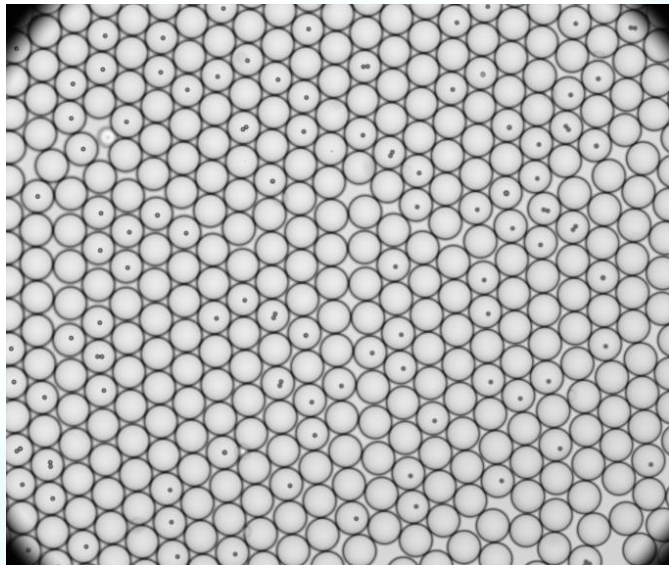

Transmission

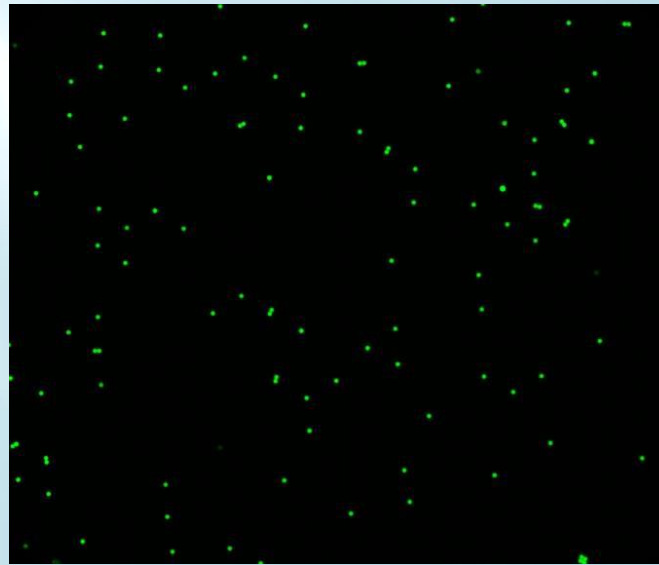

Fluorescence

- 200 pL water droplets with partly filled with WGM beads
- Plan: Measurement of released proteins from immobilized single cells
(Partner Oksana Shvydkiv, Hans-Knöll Institut Jena)

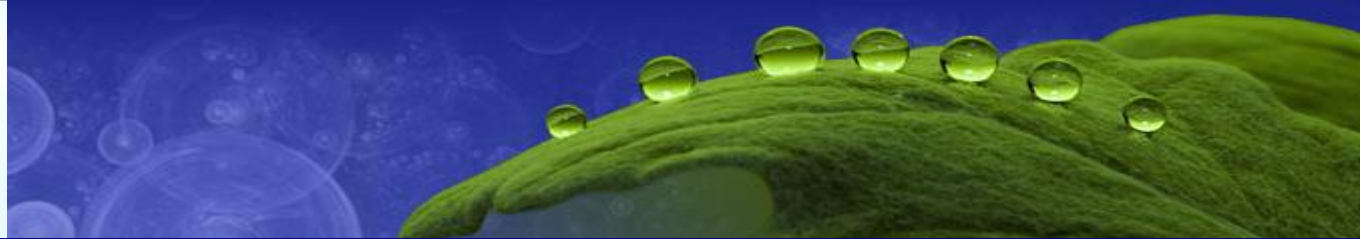

7. WGM beads in cell arrays and single cells

- Uptake of 6-7 μm particles from cells possible
- Online measurement of particle uptake in cells (M. Himmelhaus, A. Francois, Biosensors and Bioelectronics, 25 (2009) 418–427)

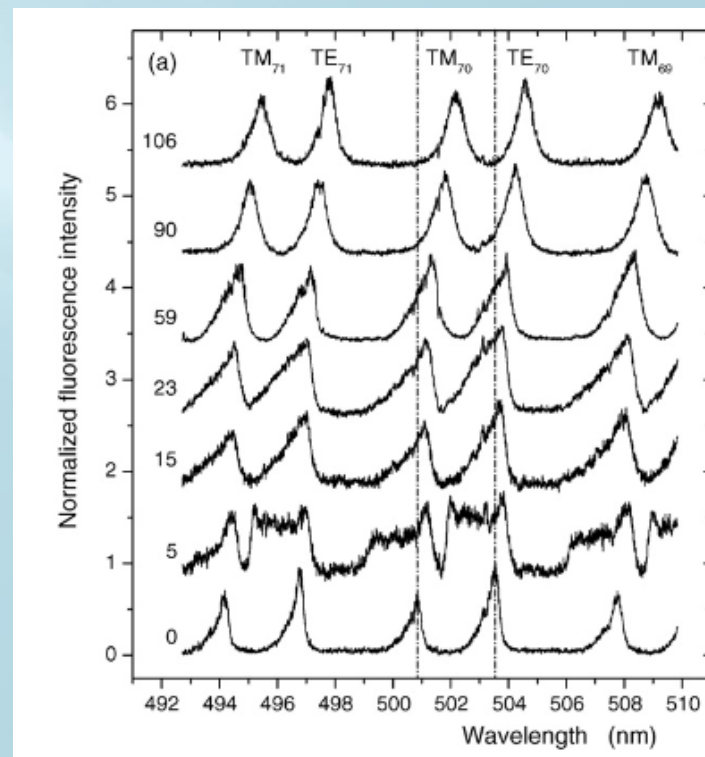
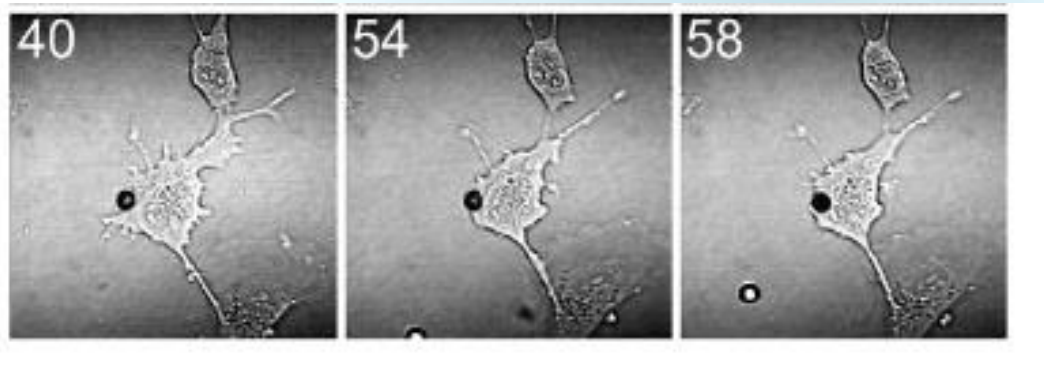

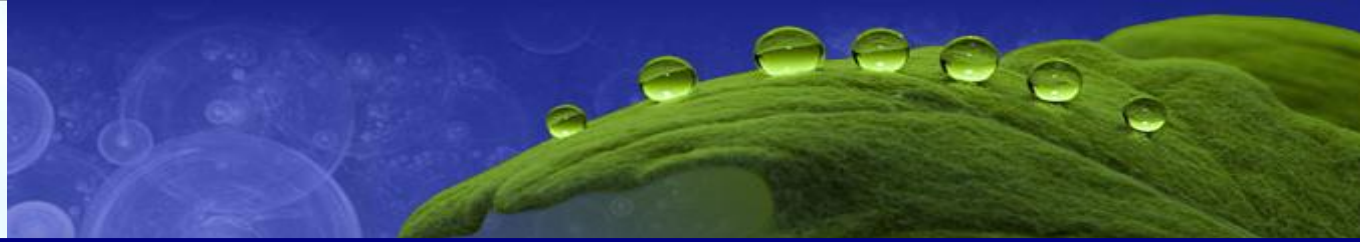

Summary

- Low Q WGM promising microtechnology for labelfree detection
- Instrumentation developed
- Functional WGM Sensor particle ready
- Biofunctionalization for specific adsorption established
- Microfluidic structures evaluated
- Searching best suited applications

Acknowledgements:

- Dr. M.Himmelhaus (NanoBioAnalytics), Instrumentation
- Dr. I. + A. Prinz STRATEC Consumables GmbH
- Dr. W. Weigel et al SCIENION AG
- BMBF for financing projects „ImmunoPlex“ und „ParFluid“

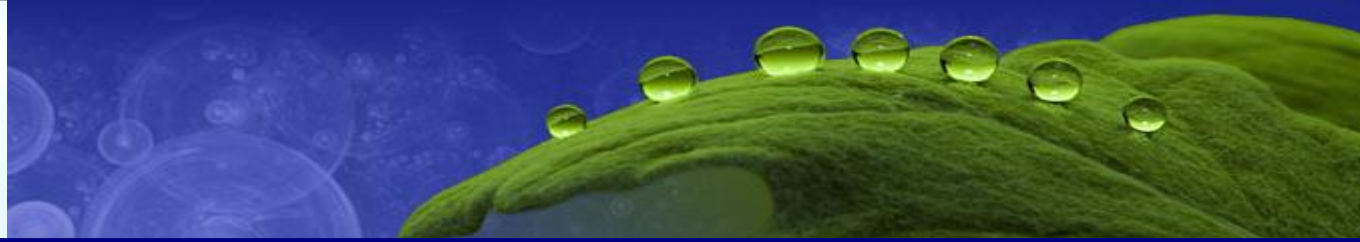

Thank you for your attention
of Surflay's work

